

Article number: 20131224

Description: E+G Ball knob DIN 319-ST-50-B20-K

Measures

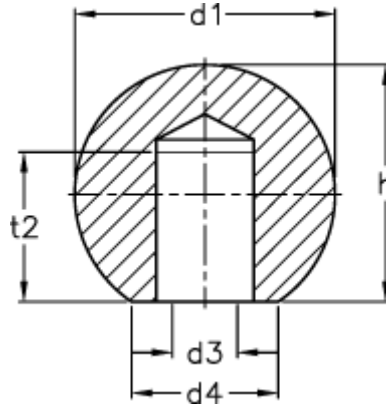

d1	= 50
d3 H7	= B20
d4	= 27
h	= 46.0
t2 min.	= 28